



**FIAMMA®**

**Bicycles carrier**

Installation and usage instructions

EN

**Fahrradträger**

Montage- und Gebrauchsanleitung

DE

**Porte-vélos**

Instructions de montage et mode d'emploi

FR

**Portabicicletas**

Instrucciones de montaje y uso

ES

**Portabici**

Istruzioni di montaggio e d'uso

IT

Please consult the website for  
instructions in the languages:  
NL-SV-DA-NO-FI-PT



## CARRY-BIKE

**PRO C / PRO C N**  
**02096-10- / 02096-10V**  
**02096-10A / 02096V10A**



**MOTORHOME**

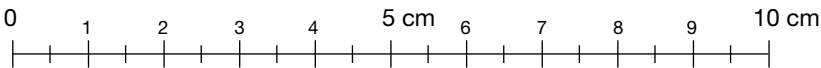
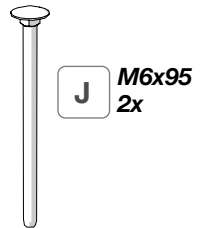
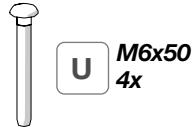
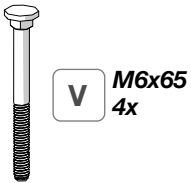
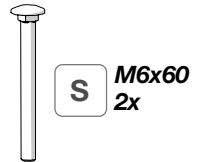
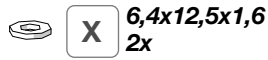
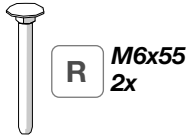
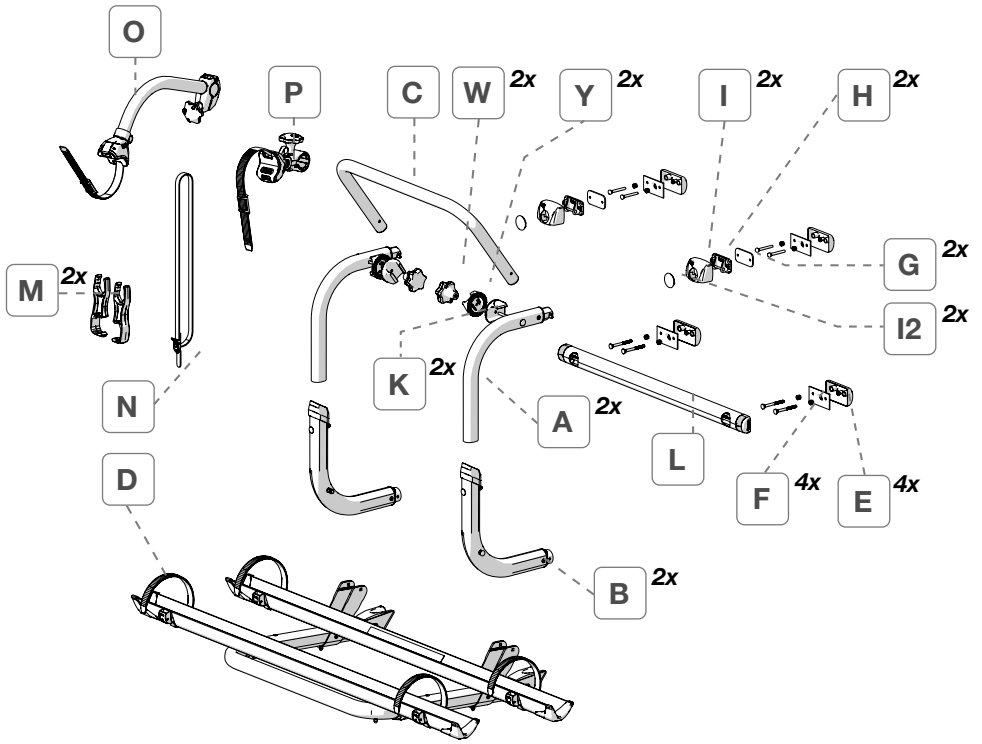

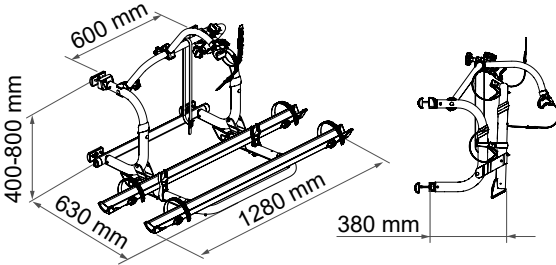
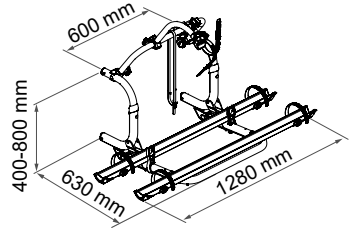
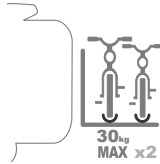
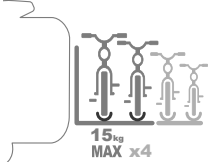
**Carry-Bike Pro C****Carry-Bike Pro C N**

Package contents / Verpackungsinhalt / Contenu de l'emballage / Contenido del embalaje / Contenuto dell'imballo	<b>p. 2</b>
Installation instructions / Montageanleitung / Instructions de montage / Instrucciones de montaje / Istruzioni di montaggio	<b>p. 4</b>
Instructions for use / Gebrauchsanleitung / Instructions d'installation / Instrucciones de uso / Istruzioni di utilizzo	<b>p. 10</b>
Safety instructions / Sicherheitshinweise / Consignes de sécurité / Instrucciones de seguridad / Avvertenze di sicurezza	<b>p. 14</b>
Accessories / Zubehör / En option / Accesorios / Accessori	<b>p. 19</b>
Warranty / Garantie / Garantíe / Garantía / Garanzia	<b>p. 19</b>



- EN** Check that nothing has been damaged or deformed during transport. In the event of doubts or questions concerning the installation, use or limitations of the product, contact the dealer. **We recommend that the installation is carried out by qualified personnel and in compliance with current local regulations.**
- DE** Bitte kontrollieren Sie, dass alle Einzelteile einwandfrei sind und nicht während dem Transport beschädigt wurden. Im Zweifelsfall oder bei Fragen zur Montage, Verwendung oder zu Einschränkungen des Produkts wenden Sie sich bitte an Ihren Händler. **Wir empfehlen die Anbringung durch Fachpersonal in Übereinstimmung mit den geltenden lokalen Vorschriften vornehmen zu lassen.**
- FR** Contrôler le contenu du colis et vérifier qu'aucune pièce n'ait été cassée ou déformée durant le transport. En cas de doutes ou de questions relatives à l'installation, l'utilisation du produit, contactez votre concessionnaire. **L'installation doit être réalisée par des personnes dûment qualifiées et conformément aux normes en vigueur dans le pays d'installation.**
- ES** Controlar que ningún detalle se haya roto o deformado durante el transporte. En caso de dudas o si tiene alguna pregunta sobre el montaje, uso y limitaciones del producto, póngase en contacto con el distribuidor. **Recomendamos que la instalación se realice por personal cualificado en conformidad con las regulaciones locales.**
- IT** Controllare che nessun particolare sia rotto o deformato a causa di errori di trasporto. In caso di dubbi o domande relative al montaggio, utilizzo e limiti del prodotto, contattare il rivenditore. **Consigliamo di far eseguire l'installazione da parte di personale qualificato ed in conformità alle vigenti normative locali.**

**EN** Before installing the product, check the strongest points of vehicles's wall, where you can fix the brackets.

**DE** Vor dem Aufstellen des Produkts kontrollieren Sie die verstärkten Punkte auf die Fahrzeugwand, um die Halterungen korrekt zu befestigen.

**FR** Avant d'installer le produit, vérifiez les points plus robustes sur la paroi du véhicule, où fixer les pattes de fixation.

**ES** Antes que instalar el producto, verificar los puntos más resistentes del vehículo donde fijar los enganches.

**IT** Prima di installare il prodotto, verificare i punti più robusti sulla parete del mezzo dove fissare gli agganci.

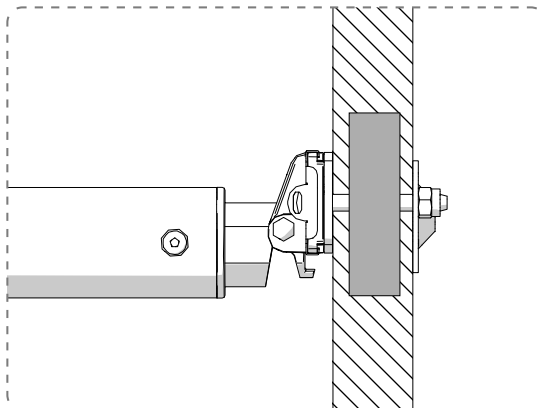

1

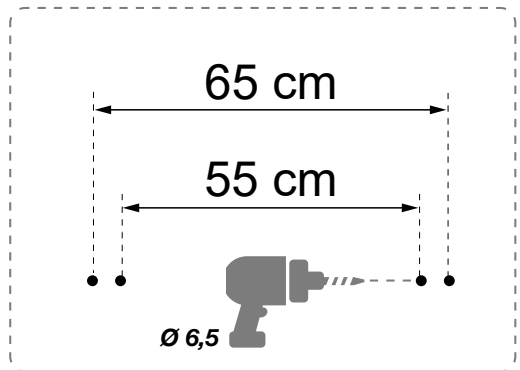
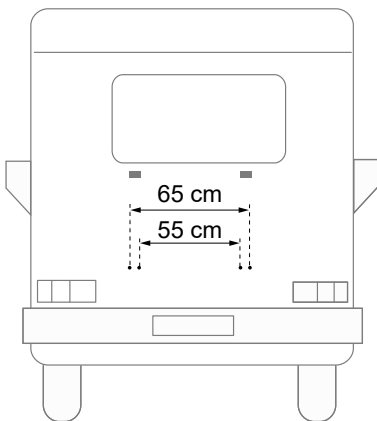
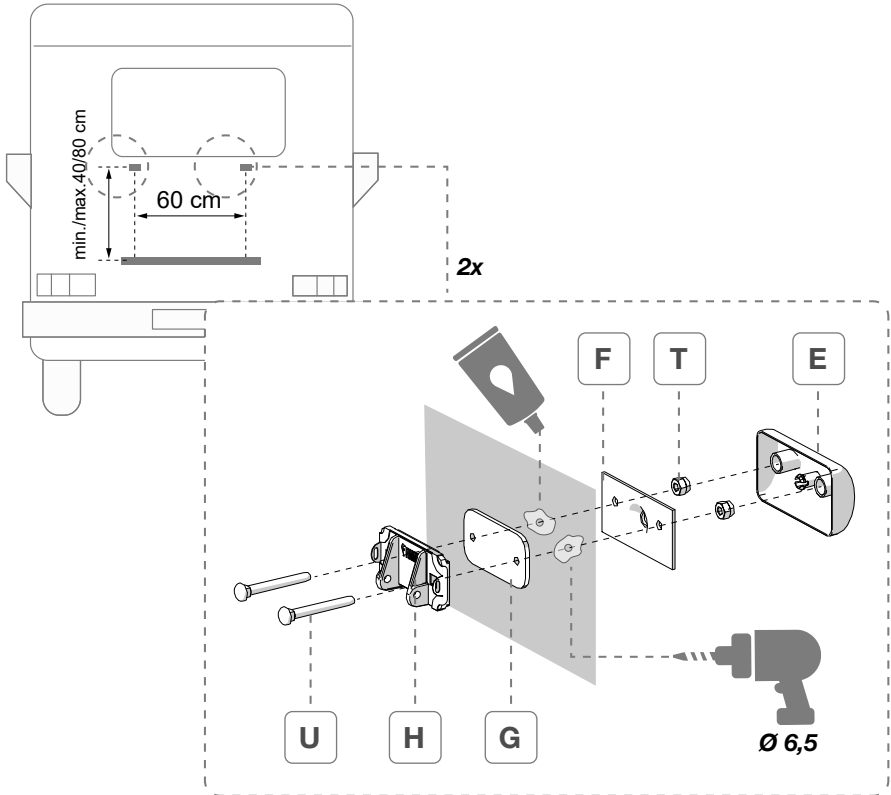



2

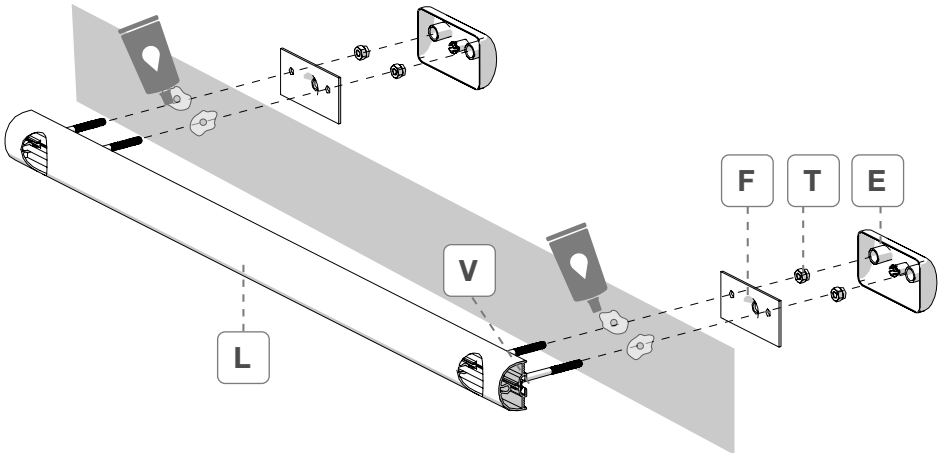
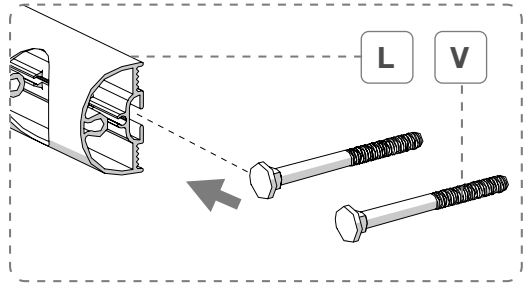
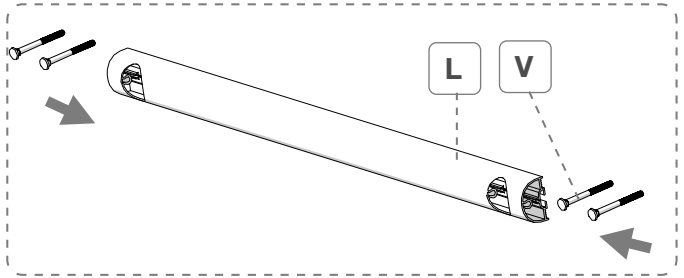
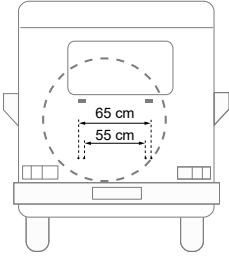

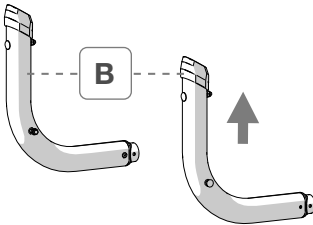
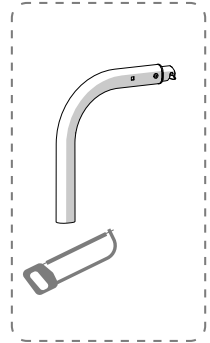
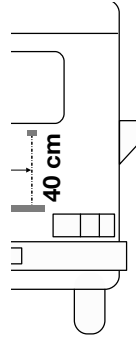
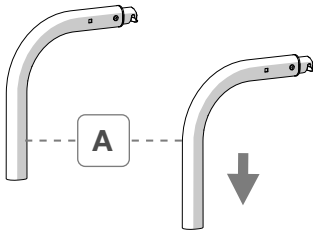
**3****EN**

Cut the tubes (A) according to the desired vertical spacing.

**DE**

Kürzen Sie die Rohre (A) entsprechend den gewünschten vertikalen Abständen zu.

**FR**

Couper les tubes (A) en fonction de l'entraxe verticale souhaité.

**ES**

Cortar los tubos (A) en base a la distancia entre ejes vertical deseada.

**IT**

Tagliare i tubo (A) in funzione dell'interasse verticale desiderato.

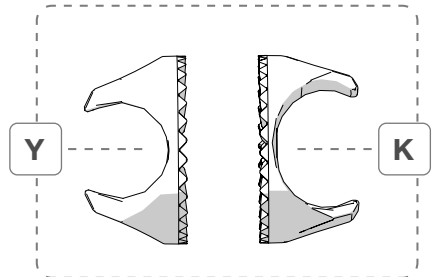
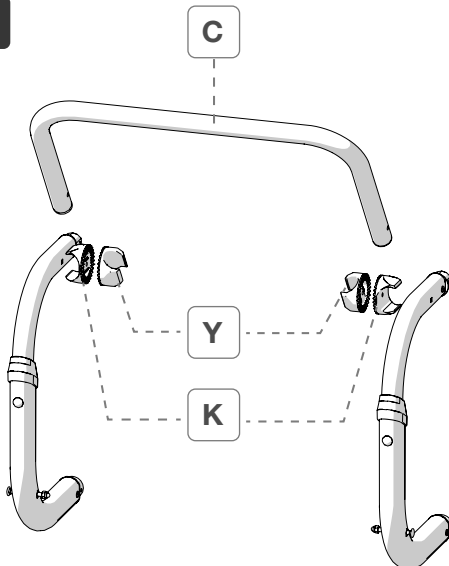
**4**



5

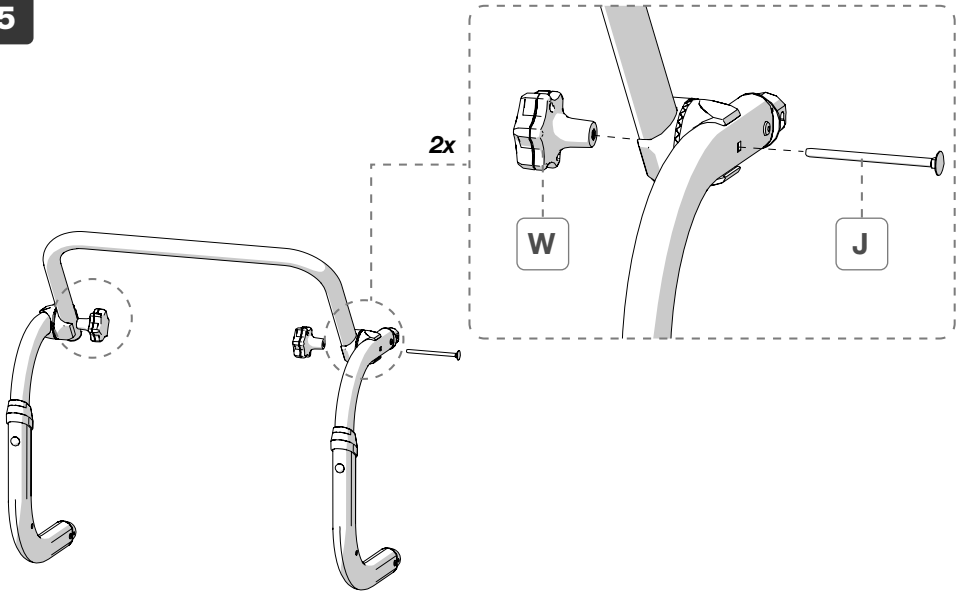

6

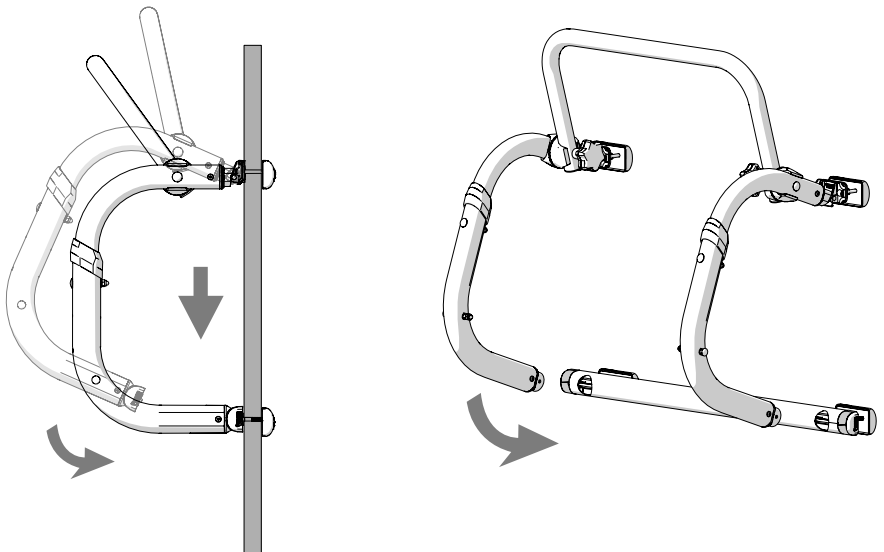



7

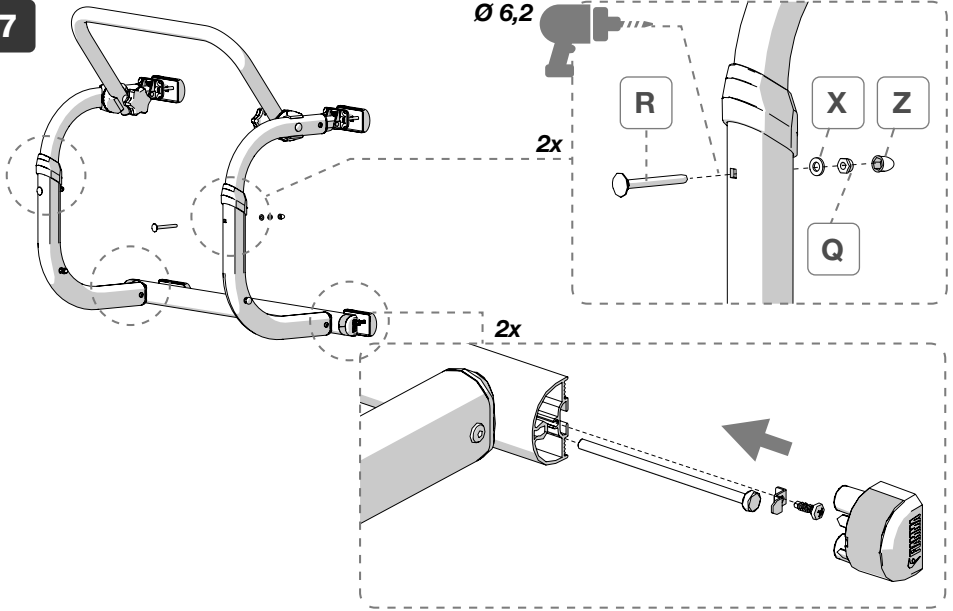

8

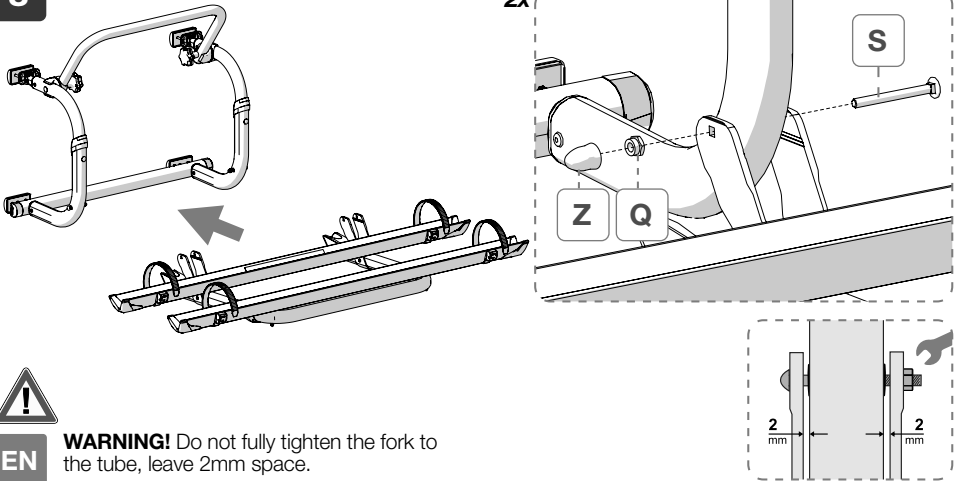

**EN** **WARNING!** Do not fully tighten the fork to the tube, leave 2mm space.

**DE** **ACHTUNG!** Die Gabel nicht komplett am Rohr festziehen, 2 mm Abstand lassen.

**FR** **ATTENTION!** Ne pas serrer complètement la fourche au tube, laisser un espace de 2 mm.

**ES**

**ADVERTENCIA!** No apretar totalmente la horquilla al tubo, dejar 2 mm de espacio.

**IT**

**ATTENZIONE!** Non stringere completamente la forcella al tubo, lasciare 2 mm di spazio.



9

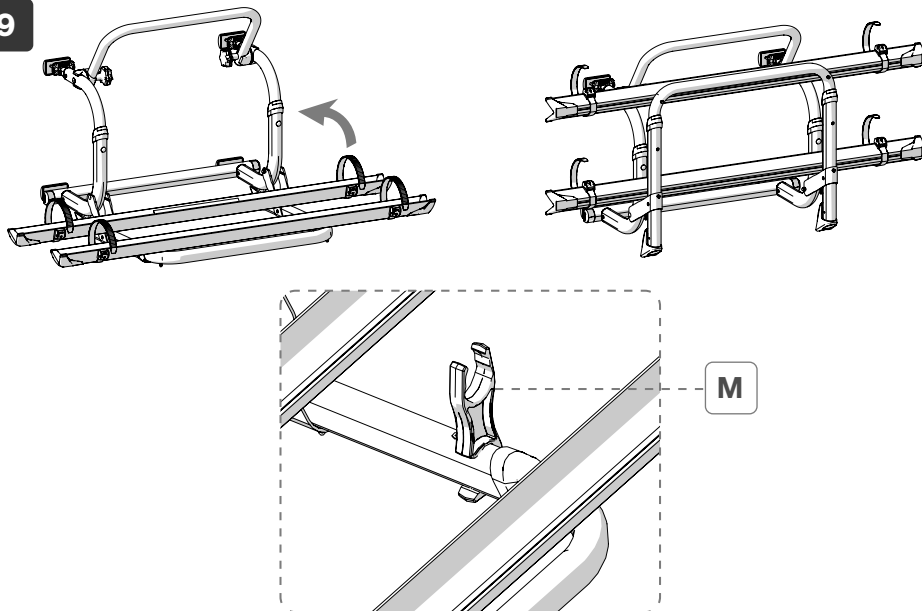

10

1

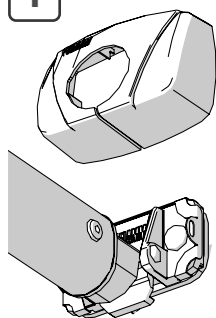

2

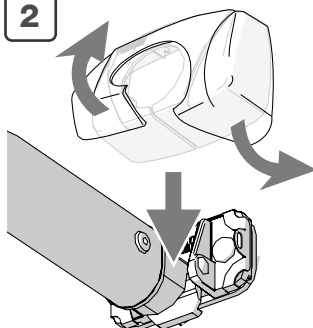

3

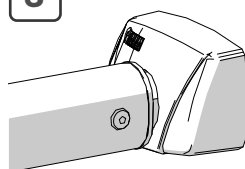

**EN** Fit the (pre-cut) upper cover to the Carry Bike fixing claw.

**DE** Montieren Sie die obere Abdeckung mit Hilfe der vorbereiteten Aussparung der Komponente.

**FR** Enfiler la couverture supérieure en tirant parti de l'entaille prévue à cet effet sur la pièce.

**ES** Ajustar la tapa superior en el corte previsto en el componente.

**IT** Calzare la copertura superiore sfruttando il taglio predisposto del componente.

11

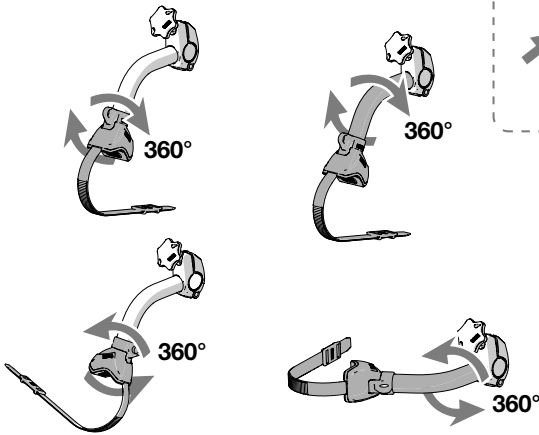
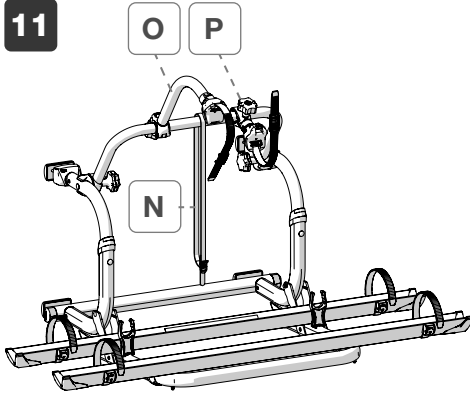

O

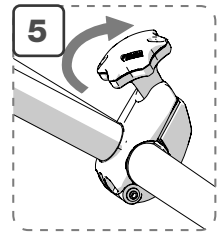
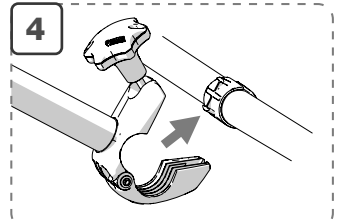
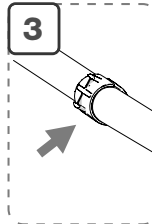
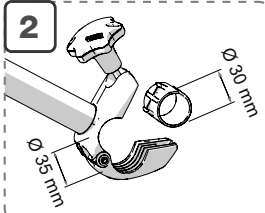
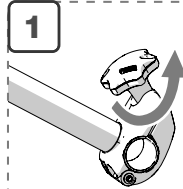

P

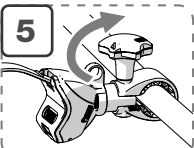
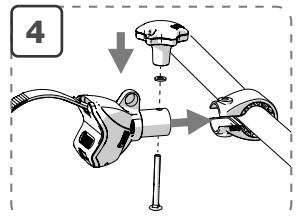
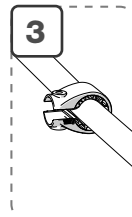
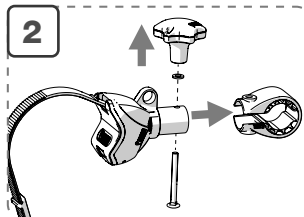
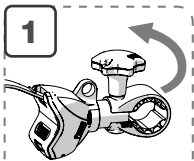

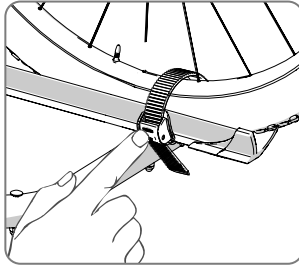
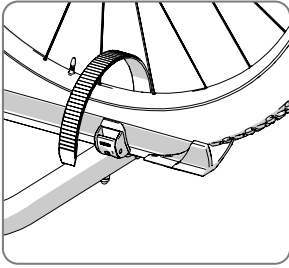

O

P

N

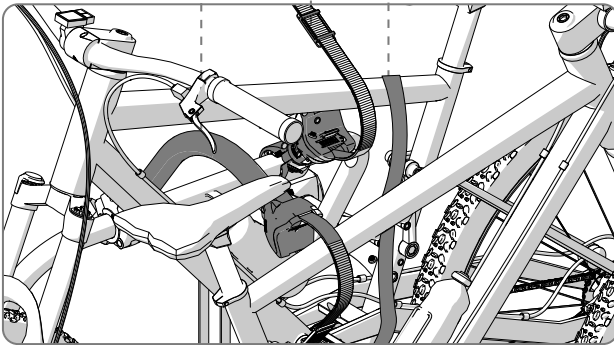

4 standard bikes

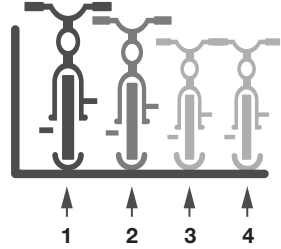

2 E-Bike

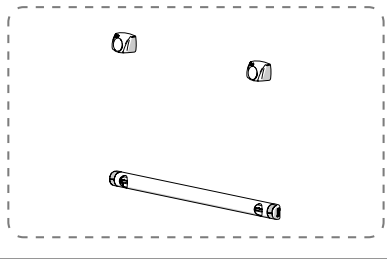
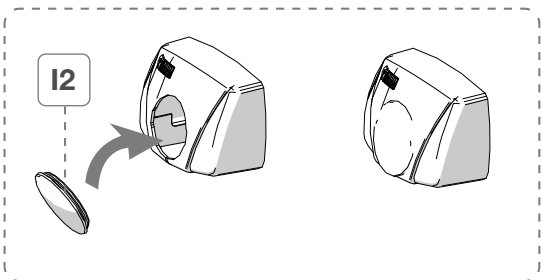
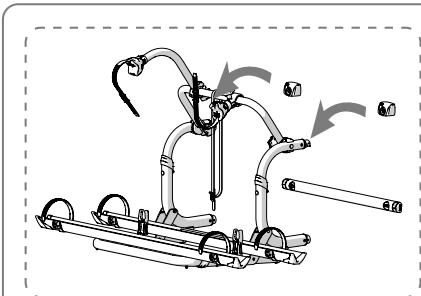
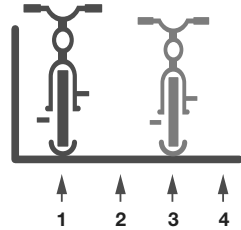



**EN** Attention: keep the following labels and affix them to the Carry-Bike rails.

**DE** Achtung: Bewahren Sie die folgenden Etiketten auf und bringen Sie diese an den Carry-Bike-Schienen an.

**FR** Attention : conserver les étiquettes suivantes ou collez-les sur les rails du Carry-Bike.

**ES** Atención: guardar las siguientes etiquetas o pegarlas en las guías del Carry-Bike.

**IT** Attenzione: conservare le seguenti etichette e applicarle sulle canaline del Carry-Bike.

<b>CARRY-BIKE®</b>	<b>FIAMMA</b>		<b>DE</b> FAHRRÄDER IMMER FESTBINDEN	<small>© Fiamma S.p.A. - Italy / Carabinieri di Cambrì (NO)</small>
Alphanumeric Code			<b>EN</b> ALWAYS SECURE THE BIKES	
Made in Italy			<b>FR</b> ATTACHEZ TOUJOURS LES VELOS	
			<b>ES</b> FIJAR SIEMPRE LAS BICICLETAS	
			<b>IT</b> FISSARE SEMPRE LE BICICLETTE	

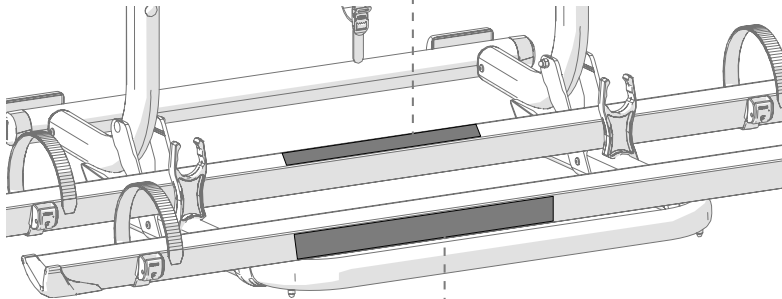

<b>CARRY-BIKE®</b>	<b>FIAMMA</b>		Item No.
PRODUCT NAME			

alphanumeric code ←



**EN** In case of problems please contact your local dealer indicating the data on the nameplate. Consult our website for spare parts drawing.

**DE** Bei Problemen bitte den Händler kontaktieren und die auf dem Etikett aufgeführten Daten mitteilen. Auf der Homepage finden Sie die Explosionszeichnung

**FR** En cas de problème, contacter le revendeur et lui communiquer les informations reportées sur la plaquette. Consulter le site Internet pour une vue éclatée des pièces de rechange.

**ES** En caso de cualquier problema, ponerse en contacto con su distribuidor local facilitando los datos sobre la placa. Consultar el sitio web para el despiece de los repuestos.

**IT** In caso di problemi contattare il rivenditore di zona, comunicando i dati riportati sulla targhetta. Consultare il sito web per l'esplosivo ricambi.



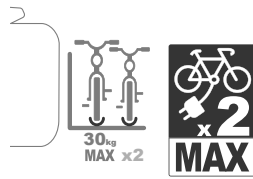
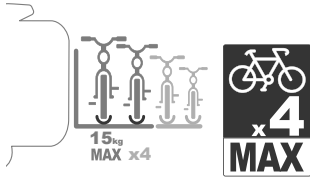

**60kg  
MAX**

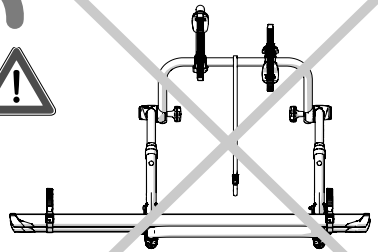
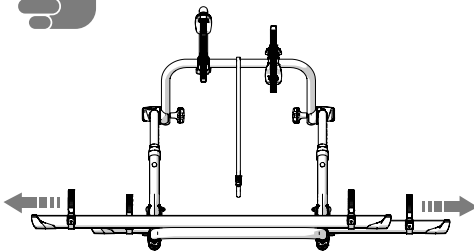
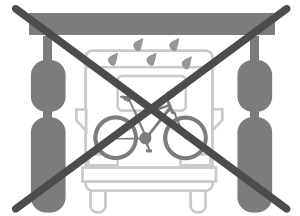
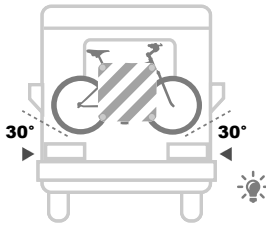
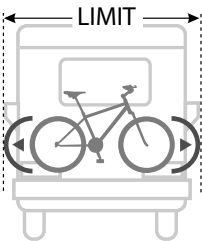
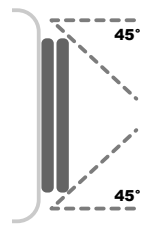
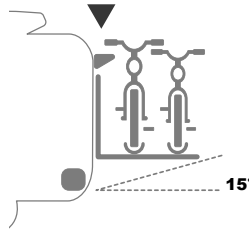



## EN

Read the following instructions and warnings carefully; failure to observe these installation and usage instructions as well as the laws for driving in the relevant country may cause severe harm or damage for which the manufacturer declines all responsibility. Before installation, ensure compatibility with the vehicle on which the product must be installed.

In the event of an accident involving the vehicle and/or the product, ensure that the product has not been damaged. In the event of damage, contact your local retailer before moving the vehicle. Fiamma declines every responsibility for any modification of the product that may cause damage and/or injury to things and people.

Checking that the wall/rear door is sufficiently solid and suitable for guaranteeing the resistance of the anchoring points is always mandatory. If not, strength and compliance with the maximum load indicated in the instructions are not guaranteed and it will be necessary to reinforce these points.

After having positioned the Carry-Bike on the rear axle of the vehicle, the normal weight distribution on both axles would be modified. This variation must not exceed the maximum permissible axle load.

Never exceed the maximum permitted length and the total weight of the full-load vehicle.

Make sure that loading occurs following a correct weight distribution; it must be uniformly distributed (the heaviest bike must be placed near the wall of the vehicle) to ensure better stability.

Always give warnings about the presence of the Carry-Bike on your vehicle, using a clearly signal for leaning loads and, in case of limited rear visibility, use the additional rear-view mirrors.

Take into account the presence of the Carry-Bike, paying attention during driving and especially during reversing manoeuvres, particularly if you have parking assist system. Always comply with speed limits and the Highway Code. The speed should always be suitable to traffic conditions and towed load. In case of use of the bike carrier with tow make sure that the tow hook is always accessible and the corner mobility of the tow is guaranteed (volume measuring din 74058).

Check periodically the bicycle rack to make sure it is firmly attached, especially during the first kilometers of after long trips to avoid damages of the Carry-Bike/vehicle. Make sure the belts are not loose and that the holding brackets have not shifted. Replace worn components immediately.

It is advisable to remove the batteries from bicycles, before loading them on the carry-bike while traveling.

It is recommended to rotate the handlebars of bicycles to avoid damage to the vehicle wall, for which Fiamma declines all responsibility.

## DE

Lesen Sie sich die folgenden Anweisungen und Warnhinweise sorgfältig durch. Die Nichtbeachtung dieser Montage- und Nutzungsvorschriften sowie der Bestimmungen der Straßenverkehrsordnung im Einsatzland kann zu schwerwiegenden Schäden führen, für die der Hersteller keine Verantwortung übernimmt.

Nach einem eventuellen Unfall, der das Fahrzeug bzw. Produkt betrifft, immer sicherstellen, dass das Produkt nicht beschädigt wurde. Im Falle von Schäden wende man sich vor der Benutzung des Fahrzeugs an den Händler. Fiamma lehnt jede Verantwortung für Veränderungen am Produkt ab, die zu Schäden und/oder Verletzungen an Sachen und Personen führen können.

Vergewissern Sie sich im Vorfeld der Montage, dass das Produkt mit dem Fahrzeug, an dem es installiert werden soll, kompatibel ist. Prüfen Sie unbedingt stets, dass die Fahrzeugwand/-tür ausreichend stabil und geeignet ist, um die Festigkeit der Ankerpunkte zu gewährleisten. Andernfalls besteht keine Garantie einer festen Anbringung und der Einhaltung der in den Anweisungen angegebenen maximalen Traglast und es müssen Verstärkungsmaßnahmen getroffen werden.

Durch die am Heck des Fahrzeugs angebrachte Ladung wird die vom Fahrzeughersteller vorgegebene Achslastenverteilung verändert. Diese Veränderung darf nicht zu einer Überschreitung der zulässigen Achslast führen.

Im beladenen Zustand dürfen die maximale Länge und Gewicht des Fahrzeugs nicht überschritten werden.



Bitte auf eine korrekte Gewichtsverteilung bei der Beladung achten; das Gewicht muss einheitlich verteilt werden (die schwereren Fahrräder nahe zum Fahrzeug) um eine erhöhte Stabilität zu gewährleisten. Die Maximallänge des Fahrzeuges darf nicht überschritten werden.

Durch Warnschilder immer auf den Fahrradträger aufmerksam machen. Bei begrenzter Sicht nach hinten wird der Einsatz von Zusatzrückspiegeln empfohlen.

Beim Mitführen des Carry-Bike auf die dadurch abgeänderte Manövrierfähigkeit achten, vor allem beim rückwärtsfahren mit Fahrzeugen, welche mit einem Parksensoren ausgestattet sind. Immer die Geschwindigkeitsbegrenzungen und die Straßenverkehrsordnung beachten. Die Geschwindigkeit muss immer an die Verkehrs- und Beladungshältnisse des Fahrzeugs angepasst werden. Beim Mitführen eines Anhängers darauf achten, dass die Anhängerkupplung jederzeit zugänglich und die Winkelbeweglichkeit gemäß der DIN74058 gewährleistet ist.

Prüfen Sie regelmäßig die Befestigung des Fahrradträgers, insbesondere nach einer ersten gewissen Fahrt und jeweils vor und nach einer längeren Fahrt. Die Schutzgummis und Riemen regelmäßig überprüfen und falls porös oder abgenutzt dringend ersetzen.

Wir empfehlen die Batterie des Fahrrades vor dem Beladen auf den Träger abzunehmen.

Es wird empfohlen, den Lenker der Fahrräder zu drehen, um eventuelle Schäden an der Fahrzeugwand zu vermeiden, wofür Fiamma nicht haftbar gemacht werden kann.

## FR

Lire attentivement les instructions de montage suivantes. Le non-respect de ces conseils d'installation ou d'utilisation mais aussi des normes relatives au code de la route du pays dans lequel vous circulez peuvent causer de graves dommages qui ne pourront aucunement engager la responsabilité du fabricant.

En cas d'accident impliquant le véhicule et/ou le produit, vérifier que le produit n'a pas été endommagé. Dans le cas contraire, contacter le concessionnaire avant de déplacer le véhicule.

Fiamma décline toute responsabilité quant aux éventuelles modifications apportées au produit pouvant entraîner des dommages et/ou lésions aux choses et aux personnes.

Avant de procéder au montage, assurez-vous de la compatibilité du produit devant être installé sur le véhicule. Il est obligatoire de vérifier que la paroi/le hayon du véhicule est suffisamment solide ou qu'elle/il est adapté/e pour garantir la résistance des points de fixation. Dans le cas contraire, la bonne tenue et la capacité maximale de chargement ne seront plus respectées et il faudra renforcer la paroi ou le hayon.

Suite à l'installation du Carry-Bike sur le train arrière du véhicule, il y aura une modification du poids par rapport à une distribution normale sur les deux essieux. Cette variation ne doit pas dépasser la charge maximale autorisée par essieu.

Ne jamais dépasser la longueur maximale admise et le poids total autorisé du véhicule en charge.

Le chargement doit se faire en respectant une correcte distribution du poids: la charge doit être distribuée de manière homogène (les vélos les plus lourds doivent être placés sur les rails les plus proches de la paroi du véhicule) pour garantir une plus grande stabilité et sans dépasser la largeur du véhicule.

Toujours signaler la présence d'un porte-vélos par l'intermédiaire d'un panneau de signalisation pour chargement dépassant le gabarit du véhicule et, en cas de visibilité arrière réduite, l'utilisation de rétroviseurs supplémentaires est recommandée.

Conduire avec un porte-vélos demande de savoir adapter son style de conduite en faisant tout particulièrement attention aux manœuvres de marche arrière, spécialement si le véhicule est équipé de dispositif d'aide au stationnement. Respecter les limitations de vitesse et le code de la route. La vitesse doit toujours respecter les conditions de circulation sur route et la charge transportée. En cas d'utilisation avec une remorque, vérifier que le crochet d'attelage soit accessible et que le mouvement angulaire de la remorque soit garanti (mesure du volume DIN 74058).





Contrôler régulièrement l'état des éléments de fixation du porte-vélos, en particulier après avoir parcouru les premiers Km suivant l'installation et, à chaque occasion, avant et après les plus longs trajets pour éviter tout dommage au Carry-Bike et/ou au véhicule. Vérifier régulièrement les éléments en caoutchouc sous les étriers supérieurs et/ou inférieurs ainsi que les sangles; s'ils devaient s'avérer poreux ou abîmés, remplacez-les immédiatement.

Conseil pour le transport: avant de charger le vélo électrique sur le porte-vélos, il est recommandé de retirer la batterie.

Il est recommandé de tourner les guidons des vélos afin d'éviter qu'ils endommagent la paroi du véhicule; la responsabilité de Fiamma ne pourrait être engagée dans le cas contraire.

**ES**

Lea atentamente las siguientes instrucciones y advertencias; el incumplimiento de estas normas de montaje y uso y de las normas del código de circulación del país por el que se circula puede causar daños graves sobre los que el fabricante declina toda responsabilidad.

En caso de accidente que afecte al vehículo o al producto, asegúrese de que el producto no haya sufrido daños. Si hay algún daño, póngase en contacto con su distribuidor local antes de mover el vehículo. Fiamma no se hace responsable de cualquier modificación del producto que pueda causar daños o lesiones a cosas y personas.

Antes del montaje, asegúrese de que el producto sea compatible con el vehículo en el que se instalará. Es obligatorio comprobar siempre la solidez suficiente de la pared/portón del vehículo y que sea adecuada para garantizar la resistencia de los puntos de anclaje. De lo contrario, la sujeción y el cumplimiento de la carga máxima indicada en las instrucciones no están garantizados y será necesario reforzarla.

A consecuencia de la instalación del Carry-Bike sobre el eje trasero de vehículo, la normal distribución de los pesos sobre los dos ejes se modifica. Es importante no sobrepasar nunca la carga máxima admisible por cada eje (verificar en el permiso de circulación).

No superar nunca la longitud máxima permitida y el peso total máximo del vehículo a plena carga.

La carga tiene que estar distribuida uniformemente y según la correcta distribución del peso (las bicis más pesadas cerca de la pared del vehículo) y no tiene que superar la anchura máxima del vehículo.

Indicar siempre la presencia del portabicicletas con una señal de cargas salientes y en caso de visibilidad trasera reducida, es aconsejable utilizar los espejos retrovisores adicionales.

Tener en cuenta la presencia del Carry-Bike, poniendo cuidado durante la conducción y especialmente mientras se realizan maniobras de marchas atrás, sobretodo si el vehículo está equipado con sensores de aparcamiento. Respete siempre el límite de velocidad y las normas de circulación. La velocidad debe adecuarse al estado del tráfico y a la carga que se transporta. Es importante verificar que en caso de uso con remolque, permanezca accesible el enganchador de vagones y que sea garantizadas movilidad angular del remolque (medidas del volumen din 74058).

Controlar periódicamente el estado de fijación del Carry-Bike sobretodo después de los primeros Kms y cada vez antes y después de los viajes más largos, asegurándose que los estribos no se hayan desplazados, para evitar daños del Carry-Bike y/o del vehículo, revisar regularmente las partes de goma debajo de los soportes superiores y / o inferiores, así como las correas; sustituir las inmediatamente si están porosas o desgastadas.

Se recomienda sacar las baterías de las bicicletas, antes de cargarlas en el carry-bike durante el viaje.

Se recomienda rotar el manillar de las bicicletas para evitar daños a la pared del vehículo, por lo que Fiamma declina toda responsabilidad.



## IT

Leggere con attenzione le seguenti istruzioni e avvertenze; il mancato rispetto di queste norme di montaggio e utilizzo nonché delle normative del codice stradale del paese di circolazione possono causare gravi danni in ordine ai quali la ditta produttrice declina ogni responsabilità.

In caso di incidente riguardante il veicolo e/o il prodotto, assicurarsi che il prodotto non abbia subito danni. In caso di danno, contattare il rivenditore locale prima di spostare il veicolo.

Fiamma declina ogni responsabilità per qualsiasi modifica del prodotto che possa causare danni e/o lesioni a cose e persone.

Prima del montaggio assicurarsi la compatibilità con il veicolo sul quale il prodotto deve essere installato. È obbligatorio verificare sempre la sufficiente solidità della parete/portellone del veicolo e che essa/o sia idonea a garantire la resistenza dei punti di ancoraggio. In caso contrario non è garantita la tenuta ed il rispetto del carico massimo indicato nelle istruzioni e si renderà necessario rinforzarla.

A seguito del posizionamento del Carry-Bike sull'asse posteriore del veicolo, la normale distribuzione dei pesi sui due assi viene modificata. Questa variazione non deve eccedere il carico massimo ammissibile per ogni asse.

Non superare mai la lunghezza massima consentita e il peso totale massimo del veicolo a pieno carico.

Fate attenzione che il carico avvenga seguendo una corretta distribuzione del peso: il carico deve essere distribuito omogeneamente (le bici più pesanti devono essere posizionate sulle canaline più vicine al veicolo) per garantire maggiore stabilità e non deve oltrepassare la larghezza massima del mezzo.

Segnalare sempre la presenza del porta biciclette con l'ausilio di un cartello indicante carichi sporgenti ed in caso di visibilità posteriore ridotta si consiglia l'utilizzo degli specchietti retrovisori supplementari.

Tenere conto della presenza del Carry-Bike, prestando attenzione durante la marcia e soprattutto durante le manovre di retromarcia, in particolar modo se il mezzo è dotato di sensori di parcheggio. Rispettare sempre i limiti di velocità ed il codice della strada.

La velocità deve sempre essere adattata alle condizioni del traffico ed al carico trasportato. Verificare che, in caso di utilizzo con rimorchio, rimanga accessibile il gancio di traino e che sia garantita la mobilità angolare del rimorchio (misurazione del volume DIN 74058).

Controllare periodicamente lo stato di fissaggio del portabiciclette soprattutto dopo aver percorso i primi Km dal montaggio ed ogni volta prima e dopo i viaggi più lunghi, per evitare il danneggiamento del Carry-Bike e/o del veicolo, verificare regolarmente le parti in gomma sotto le staffe superiori e/o inferiori, così come le cinghie; in caso risultino porose o logorate, sostituirle immediatamente.

È consigliabile rimuovere le batterie dalle biciclette, prima di caricarle sul portabici durante il viaggio.

Si raccomanda di ruotare i manubri delle biciclette per evitare danni alla parete del veicolo, per i quali Fiamma declina ogni responsabilità.

**RAIL PLUS / XL**

Item No. 98656M566

Item No. Deep Black 98656M567

Item No. 98656M588

Item No. Deep Black 98656M589

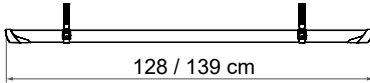
**RAIL PREMIUM / XL**

Item No. 98656M131

Item No. Deep Black 98656M150

Item No. 98656M132

Item No. Deep Black 98656M153

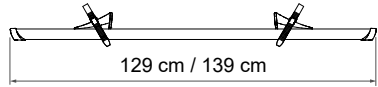
**BIKE-BLOCK PRO S****BIKE-BLOCK PRO S D****BIKE FRAME ADAPTER**

Item No. 06602-01-

**PLASTIC SIGNAL**

Item No. 98782-005

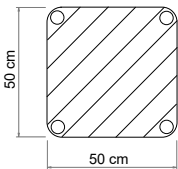
**ALU SIGNAL**

Item No. 98782-010

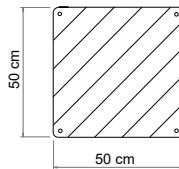
**CABLE-LOCK**

Item No. 98656-338

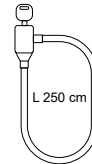

**EN** **Warranty Fiamma.** In case of defects with regards to materials and manufacturing, the customer is entitled to the warranty in accordance with local laws and regulations of the country in which the product was purchased.

**DE** **Garantie Fiamma.** Im Falle einer Mangelhaftigkeit der Ware, kann der Verbraucher unter den erforderlichen Voraussetzungen gegenüber dem Verkäufer von dem Garantieanspruch zu den festgelegten Bedingungen gemäss den lokalen Rechtsvorschriften Gebrauch machen.

**FR** **Garantie Fiamma.** En cas d'un défaut de conformité du produit, le consommateur pourra faire valoir ses droits de recours en garantie selon les modalités prévues par les dispositions légales locales, pour autant que les conditions de recours soient satisfaites.

**ES** **Garantía Fiamma.** En caso de fallos o defectos de material y de fabricación, el cliente puede hacer valer la garantía de acuerdo con las leyes y reglamentaciones del país en el que el producto haya sido comprado.

**IT** **Garanzia Fiamma.** In caso di difetto di conformità dei beni, il consumatore potrà far valere nei confronti del venditore la garanzia secondo le modalità previste dalle disposizioni di legge locali, ove ne ricorrano i presupposti.



fiamma.com

**Fiamma S.p.A. - Italy**

Via San Rocco, 56  
21010 Cardano al Campo (VA)



All rights reserved.

**Fiamma S.p.A.**

reserves the right to modify at any time,  
without notice, prices, materials,  
specifications and models or to cease  
production of any model.